

Croma
SAM Set Plus 160, 2.0 GPM
 Finishes : **chrome** Part no. : **04526000**



Description

Features

- Flow: 2.0 GPM (7.6 L/Min)
- Exposed installation
- The adjustable handshower holder on this model should not be used with a handshower with a spray face larger than 125 mm (5") in diameter
- Locking push-button diverts flow to handshower

Item details

List Price \$ 613.00

Technology



Compliance

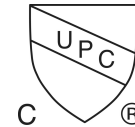

Product image



Scale drawing

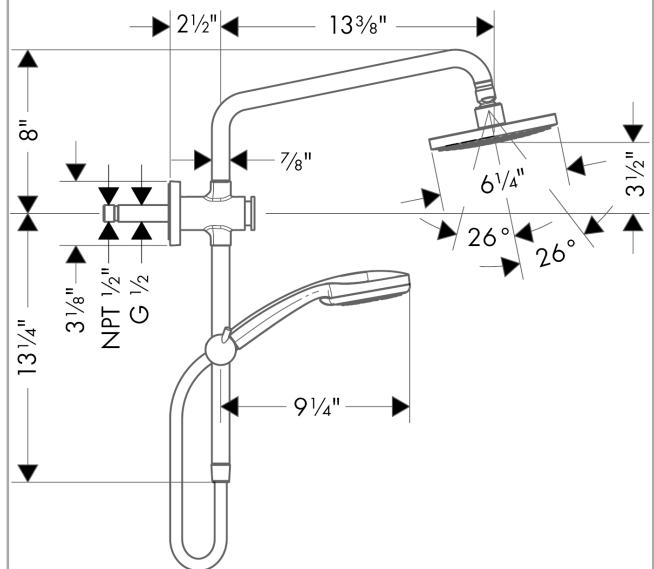

Croma
SAM Set Plus 160, 2.0 GPM
 Finishes : **chrome** Part no. : **04526000**



Exploded drawing

Year of production: >07/14

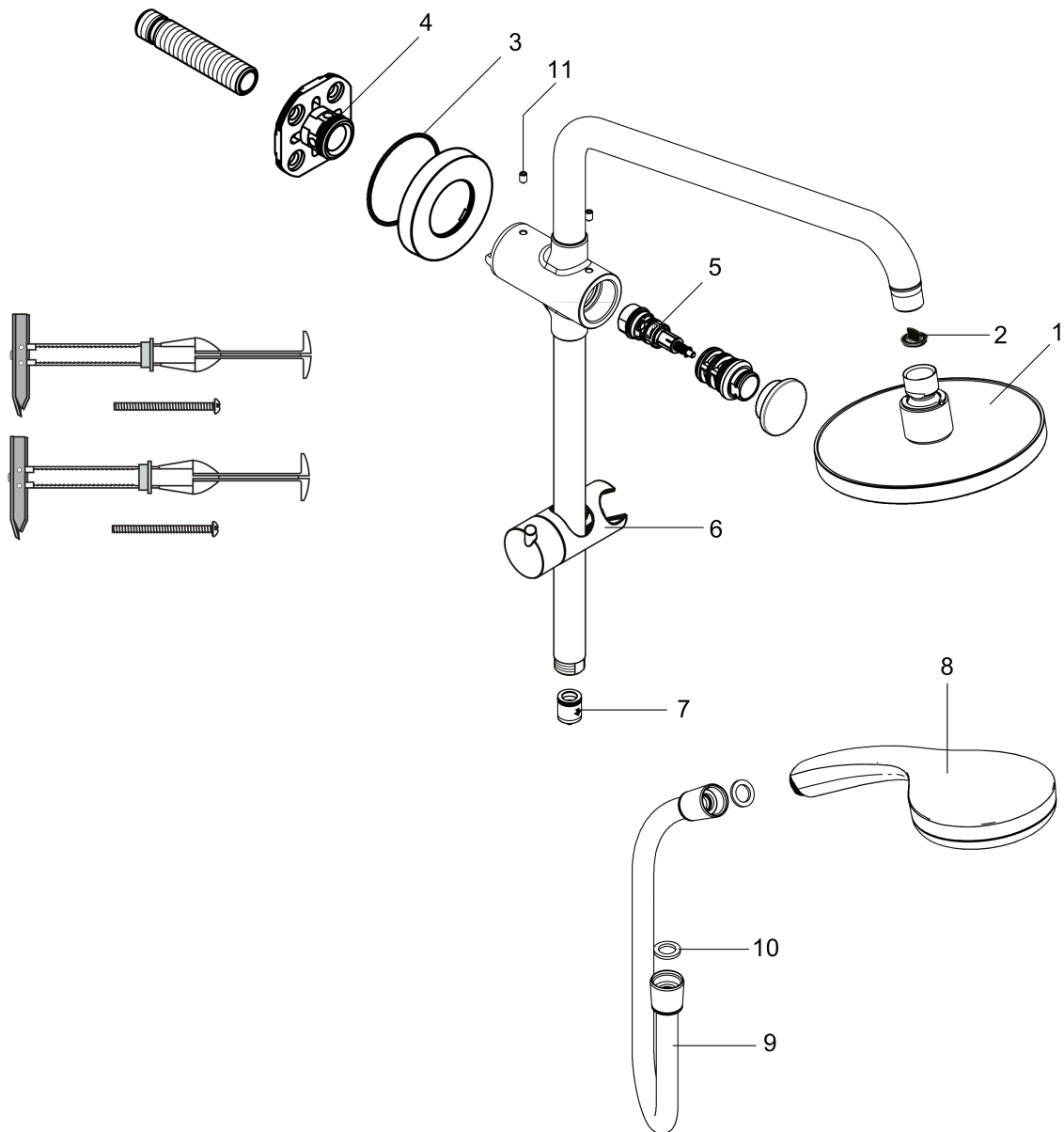

Croma
SAM Set Plus 160, 2.0 GPM
 Finishes : **chrome** Part no. : **04526000**



Spare parts list

Year of production: >07/14

Pos.	Description	Part no.	Price	PU
1	showerhead cpl.	28450001	-	1
2	filter packing	88649000	-	1
3	O-ring 65x2	98472000	-	1
4	O-ring 25x2,5	92146000	-	1
5	selector (invers)	95657000	-	1
6	support, assy	95160000	-	1
7	set of non return valves DW 15	94074000	-	1
8	handshower	04083000	-	1
9	shower hose 1,60 m	28276003	-	1
10	seal	98058000	-	1
11	hollow set screw M5x8	92851000	-	1